

**2 Way 0° Power Divider, 5 – 1000MHz**

**MAPDCT0002** V3

**Features**

- SMT unit
- 2 Way 0 Degree
- Available on tape & reel
- Excellent isolation

**Description**

M/A-COM's MAPDCT0002 is a 2 Way 0° Power Divider in a low cost, surface mount package. Ideally suited for high volume CATV & VSAT applications. Two 0603 1pF capacitors and one 200 Ohm resistor are required with this part.

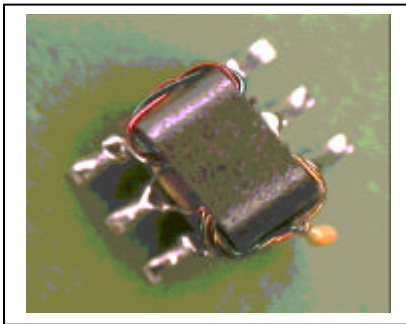
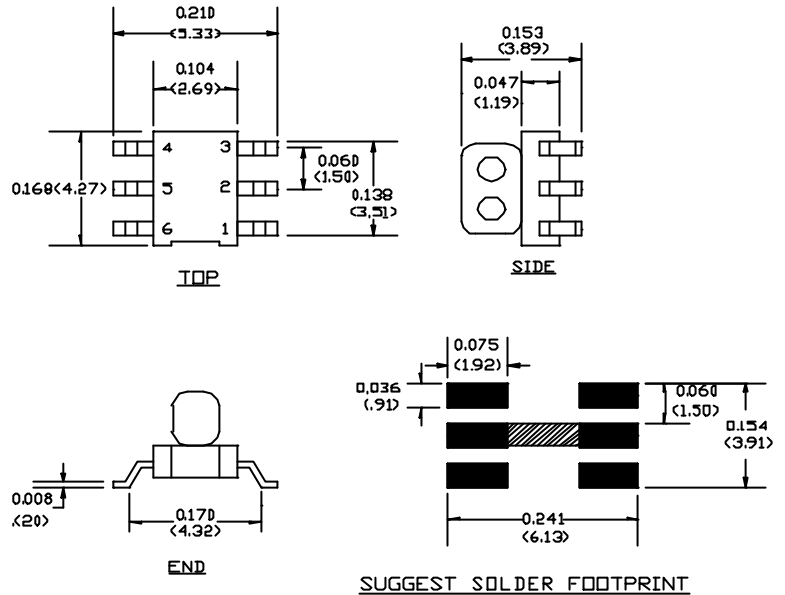

**SM-150 Case Style**

Dimensions in inches [mm] Tolerance: .xx ± .02, .xxx ± .010  
 Note: Short pin 2 and 5 on the application PCB as shown above with hatching.

**Electrical Specifications @ 25°C, 75 Ohm**

Frequency Range 40 - 1000 MHz	Test Conditions	Nominal	Units	Min.	Typ.	Max.
Insertion Loss (Above 3dB)	5 - 400 MHz	—	dB	0.5	0.3	—
	400 - 820 MHz	—	dB	1.1	0.5	—
	820 - 1000 MHz	—	dB	2.2	1.1	—
Isolation	5 - 400 MHz	—	dB	18	35	—
	400 - 820 MHz	—	dB	20	32	—
	820 - 1000 MHz	—	dB	14	20	—
Amplitude Unbalance	5 - 400 MHz	—	dB	—	0.2	0.5
	400 - 820 MHz	—	dB	—	0.2	0.3
	820 - 1000 MHz	—	dB	—	0.4	0.9
Phase Unbalance	5 - 400 MHz	—	°	—	0.5°	4°
	400 - 820 MHz	—	°	—	1°	4°
	820 - 1000 MHz	—	°	—	1.5°	6°
Input Return Loss	5 - 400 MHz	—	dB	23	35	—
	400 - 820 MHz	—	dB	16	22	—
	820 - 1000 MHz	—	dB	17	24	—

M/A-COM Inc. and its affiliates reserve the right to make changes to the product(s) or information contained herein without notice. M/A-COM makes no warranty, representation or guarantee regarding the suitability of its products for any particular purpose, nor does M/A-COM assume any liability whatsoever arising out of the use.

• North America Tel: 800.366.2266 / Fax: 978.366.2266  
 • Europe Tel: 44.1908.574.200 / Fax: 44.1908.574.300  
 • Asia/Pacific Tel: 81.44.844.8296 / Fax: 81.44.844.8298

**2 Way 0° Power Divider, 5 – 1000MHz**

**MAPDCT0002**

**Pin Configuration**

Function	Pin Number
Input	4
Output 1	1
Output 2	6
Ground	3
2 x External shunt 1pF cap, short pin 2&5 together	2 & 5

**Absolute Maximum Ratings <sup>1</sup>**

	Absolute Maximum
RF Power	1 Watt
Internal Load Dissipation	0.125 Watt
Operating/Storage Temperature	-40° C to +85° C

**Schematic**

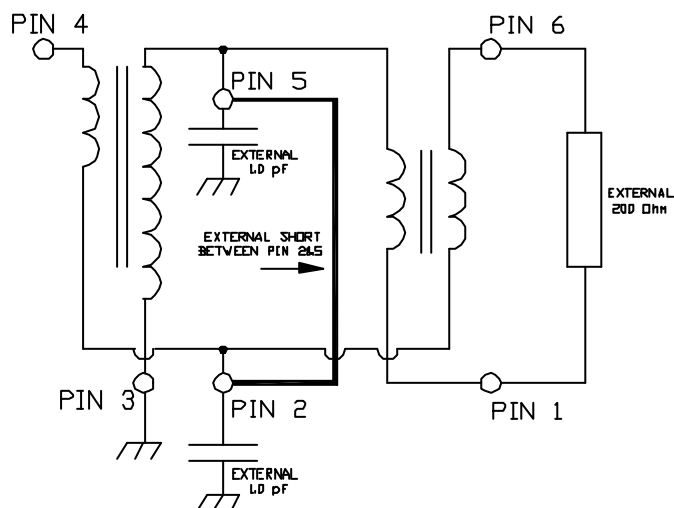

<sup>1</sup> Exceeding one or a combination of these settings may cause permanent damage to the unit

M/A-COM Inc. and its affiliates reserve the right to make changes to the product(s) or information contained herein without notice. M/A-COM makes no warranty, representation or guarantee regarding the suitability of its products for any particular purpose, nor does M/A-COM assume any liability whatsoever arising out of the use.

- North America Tel: 800.366.2266 / Fax: 978.366.2266
- Europe Tel: 44.1908.574.200 / Fax: 44.1908.574.300
- Asia/Pacific Tel: 81.44.844.8296 / Fax: 81.44.844.8298

**2 Way 0° Power Divider, 5 – 1000MHz**

**MAPDCT0002**

**Typical Performance Curves @ +25° C, 75 Ohm**

**Insertion Loss**

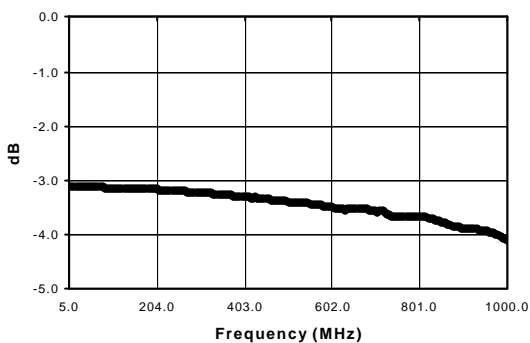

**Input Return Loss**

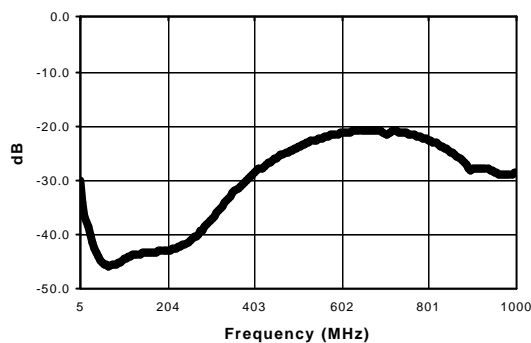

**Amplitude Unbalance**

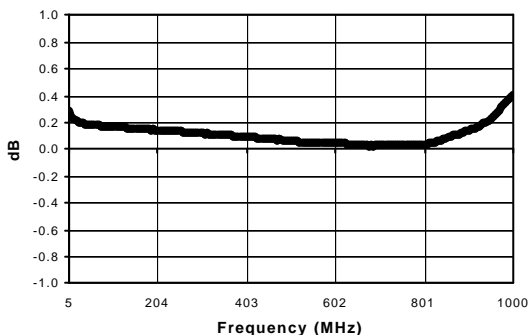

**Phase Unbalance**

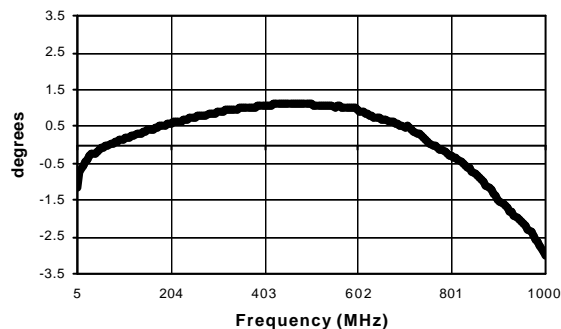

**Isolation**

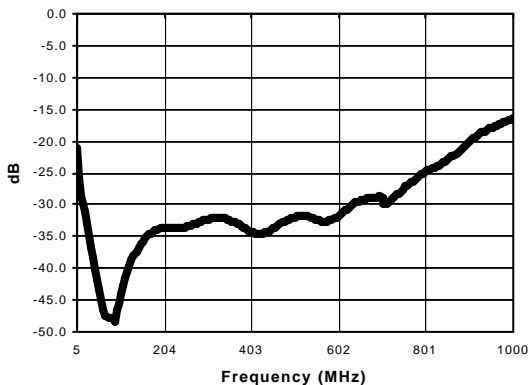

M/A-COM Inc. and its affiliates reserve the right to make changes to the product(s) or information contained herein without notice. M/A-COM makes no warranty, representation or guarantee regarding the suitability of its products for any particular purpose, nor does M/A-COM assume any liability whatsoever arising out of the use.

- North America Tel: 800.366.2266 / Fax: 978.366.2266
- Europe Tel: 44.1908.574.200 / Fax: 44.1908.574.300
- Asia/Pacific Tel: 81.44.844.8296 / Fax: 81.44.844.8298